

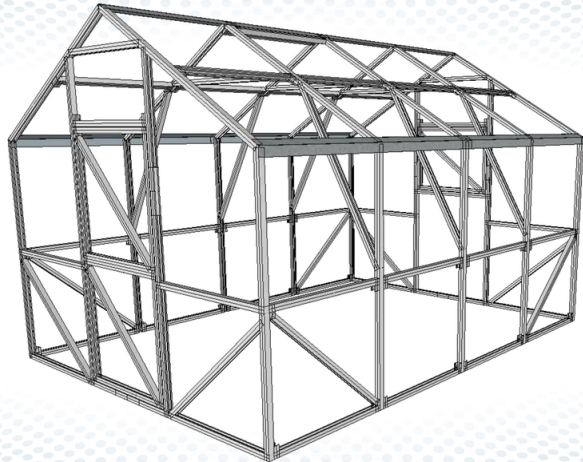







## Instruction for assembling the 3x4m Greenhouse.

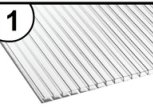
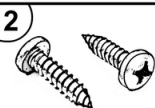
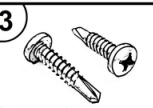

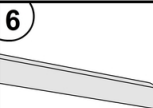
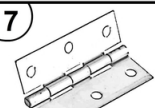
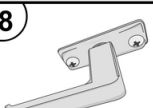
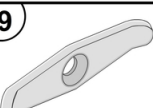
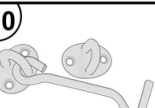
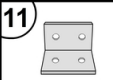
www.weisa.lv

### Equipment

|  |  |   |   |   |
|--|--|---|---|---|
|                 | <b>Connection Element set</b><br>1 box.  |               | <b>Set of Frame profiles</b><br>3 boxes.  |   |
| <b>1</b><br>   | <b>2</b><br>  | <b>3</b><br> | <b>4</b><br> | <b>5</b><br>  |
| Polycarbonate<br>(thickness 4 mm,<br>1 sheet is 2,1x6m),<br>4 sheets.                            | Frame screws<br>(DIN7981-5.5x19) 410 pcs.  | For mounting<br>hinges and Roof skates.<br>Self-tapping screws<br>(DIN7504N-4.8x19) 100 pcs.    | Washers for polycarbonate<br>(DIN9021 M8) 300 pcs   | Screws for polycarbonate<br>(DIN7981-4.8x19) 300 pcs  |
| <b>6</b><br>   | <b>7</b><br>  | <b>8</b><br> | <b>9</b><br> | <b>10</b><br> |
| Roof skates/edges<br>8 pcs.  | Hinges<br>6 pcs.   | Door Handles<br>1 pcs.  | Latches<br>2 pcs.   | Hooks<br>3 pcs.   |
| <b>11</b><br> | <b>12</b><br> | <b>Connection Elements</b><br>54 pcs.   |   |   |
| Corner 30x30<br>1gab.  |  |              |              |   |

www.weisa.lv

**Main View:**

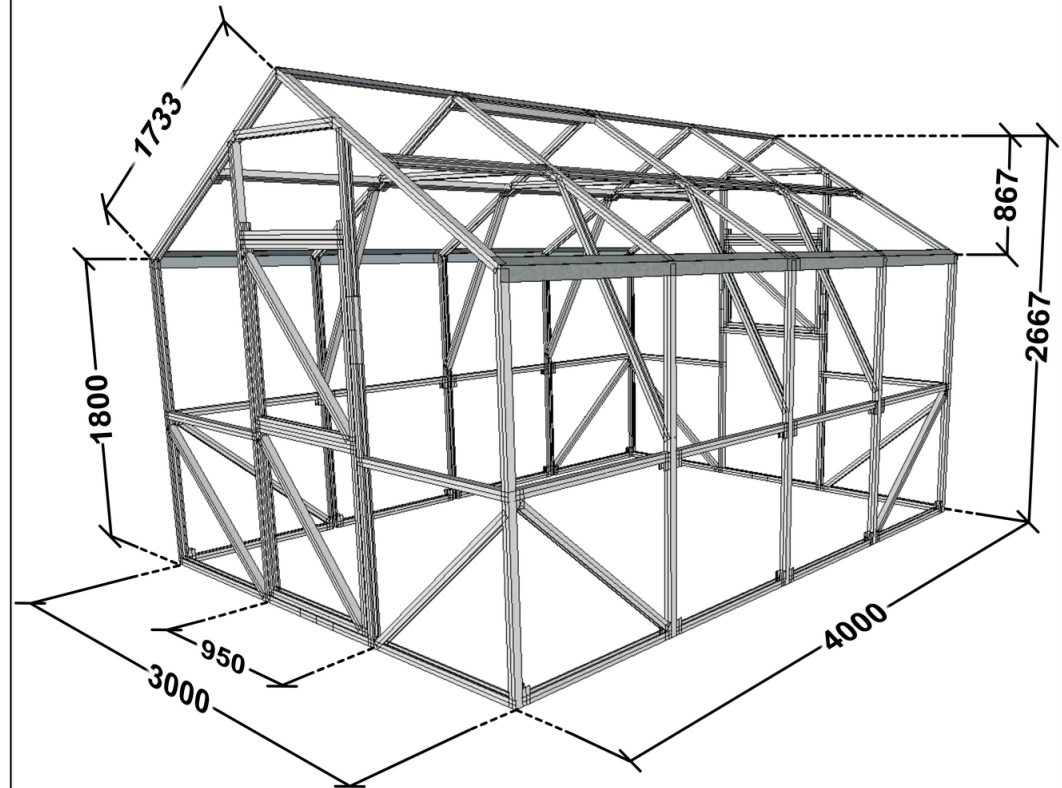

Door height: 1780 mm.  
Door width: 940 mm.



Front View:

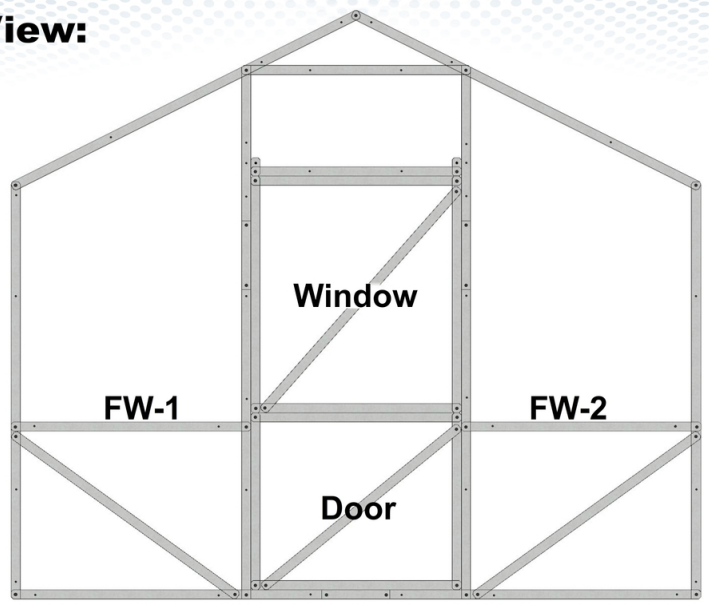

Side View:

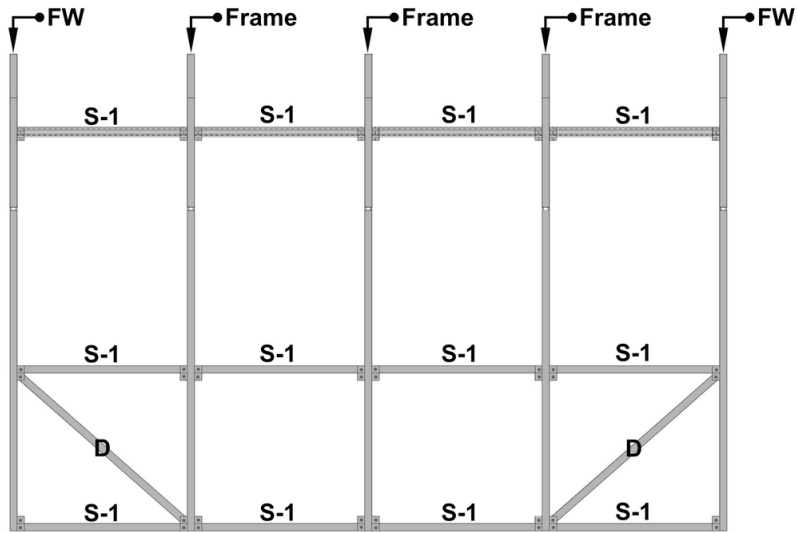

Top View:

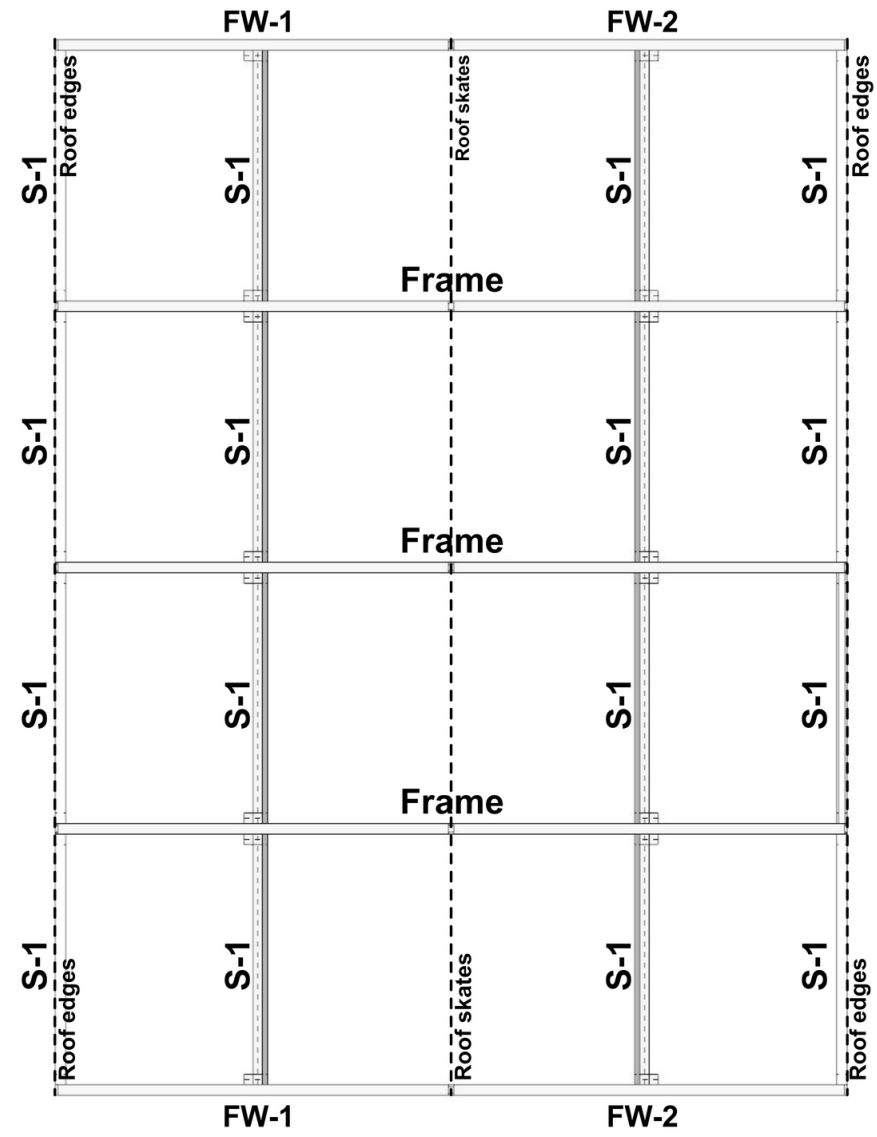

# Instruction for assembling the 3x4m Greenhouse.



www.weisa.lv

1

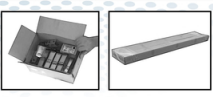

Unpack **One** box of **Connection Elements** and **One** box of **End Wall** profiles.

2

## Assemble **Connection Joints** of "FW" end wall panels:

Assemble **Joint 1** (Frame Base), from parts **1, 2, 3** according to the diagram, then Assemble **Joint 2** (Frame Beam), from parts **4, 5, 6** according to the diagram, then Assemble **Joint 3** (Frame Beam), from parts **7, 8, 9** according to the diagram below.

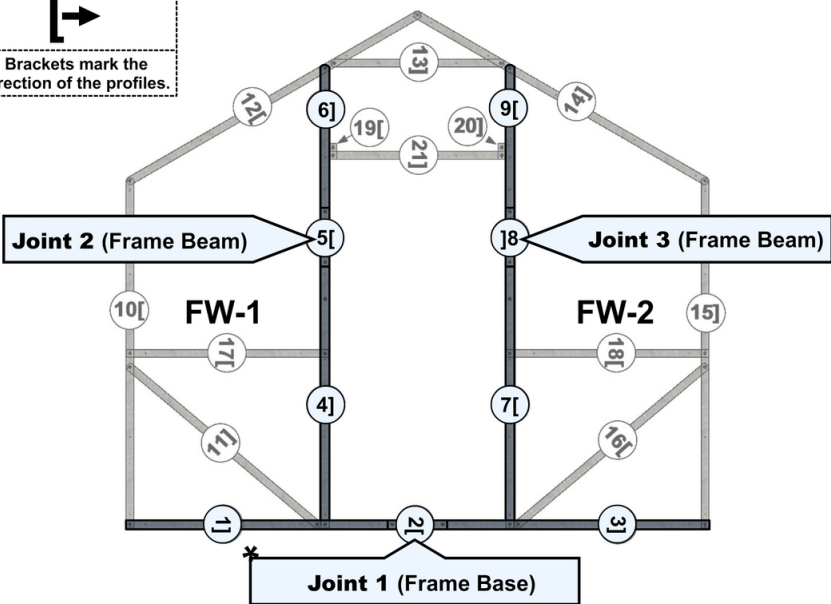
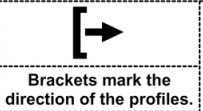

## Assembly diagram of connection Joints:

Connection Joint Profiles and panels are fastened with Frame screws (5.5x19).

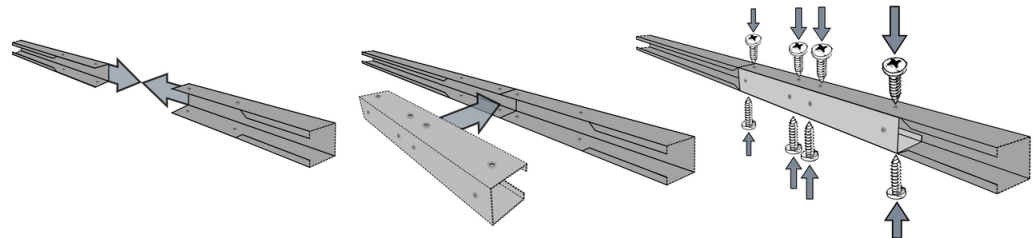

# Instruction for assembling the 3x4m Greenhouse.



www.weisa.lv

## Assemble "FW" end wall panel fastening the panel with frame screws:

Fasten the panel with frame screws (5.5x19) according to the diagram.

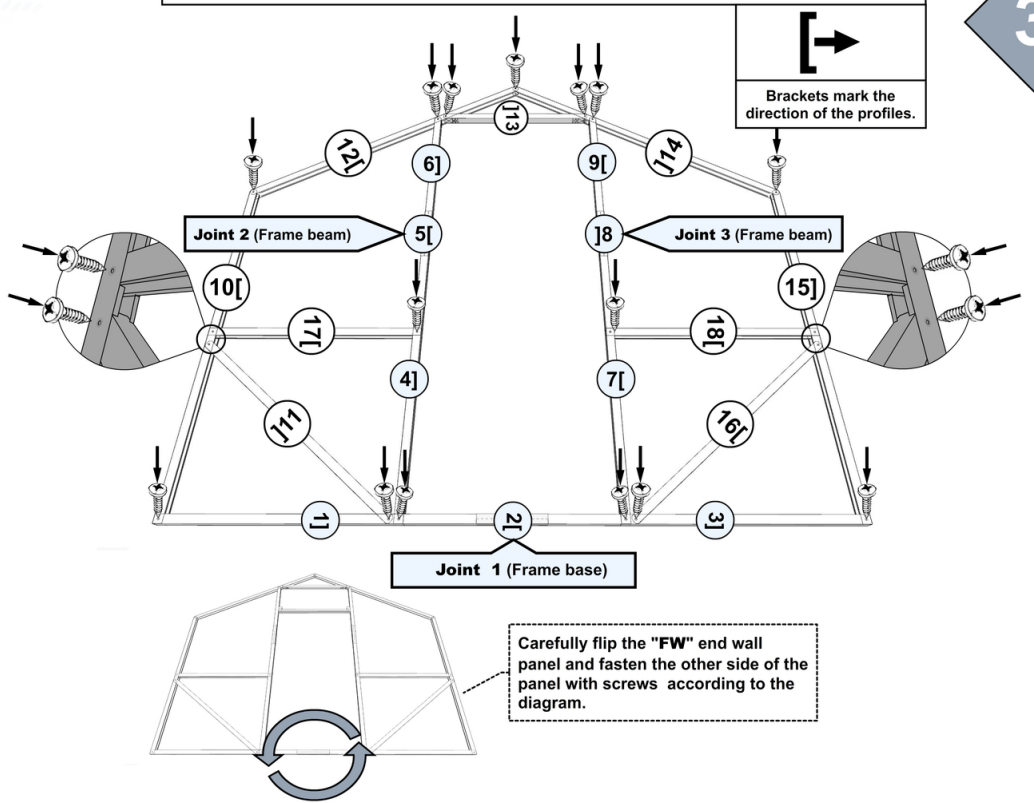

## Fasten Connection Elements 19 and 20 with the "FW" panel by fastening screws according to the diagram:

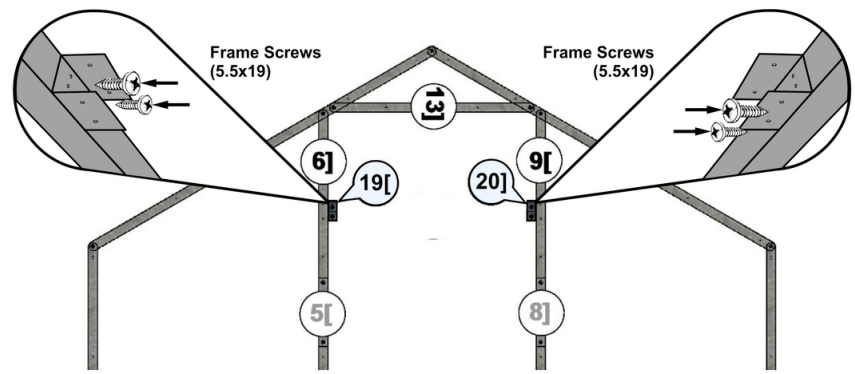

3

4

Instruction for assembling the 3x4m Greenhouse.



Install profile **21** fastening it with screws according to the diagram:

**5**

www.weisa.lv

Fasten Connection Elements with "FW" end wall panel:

**6**

Frame screws (5.5x19)

**Connection Elements** are fastened through triple holes in FW end wall panel beams with screws. Connection points are marked in the figure.

Frame screws (5.5x19)

Repeat step 1 - 6 to assemble the **Second "FW"** end wall panel:

**7**

Page. **07**

Instruction for assembling the 3x4m Greenhouse.



Unpack **One** box of "Frame" profiles.

**8**

www.weisa.lv

Assemble "Frame" panel and fasten it with screws:

Fasten the panel with frame screws (5.5x19) according to the diagram.

Brackets mark the direction of the profiles.

Carefully flip the "Frame" panel and fasten the other side of the panel with screws according to the diagram.

**9**

Fasten the **Connection Elements** with panels "Frame":

**10**

Frame screws (5.5x19)

Frame screws (5.5x19)

Frame screws (5.5x19)

**Connection Elements** are fastened on both sides through triple holes in Frame end wall panel beams with frame screws. Connection points are marked in the figure.

Page. **08**

# Instruction for assembling the 3x4m Greenhouse.



**11** Repeat step 8 and 10 to assemble 2 additional "Frame" panels ( 3 pcs in total ).

www.weisa.lv

Assemble the frame by fastening together the panels and **Connection Elements**:

- 12**
- 1) Connect the "S-1" and "D" connection elements to the end wall "FW".
  - 2) Connect the "FRAME" panel.
- Fasten the panels with frame screws (5.5x19) according to the diagram:

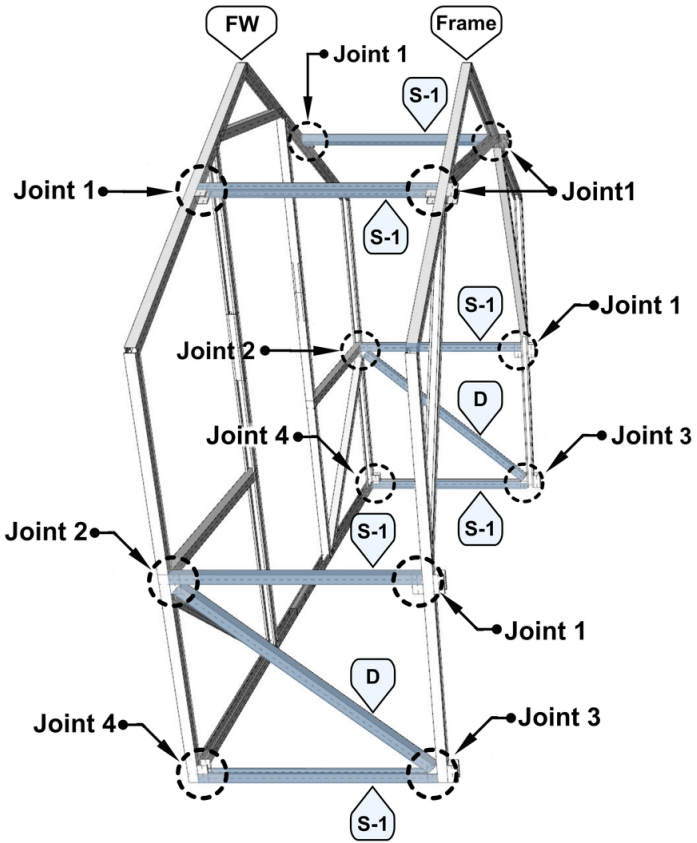
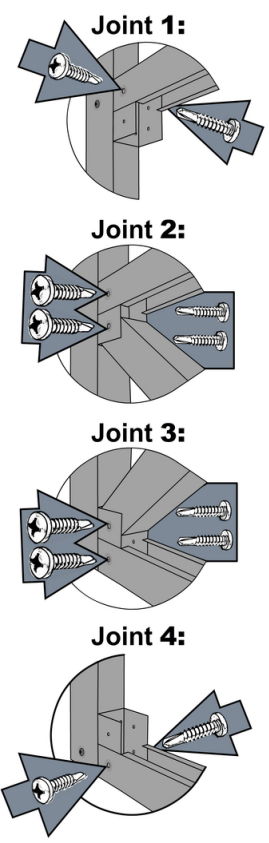

During montage assistance of a 2nd person is recommended.

Similarly assemble the rest of the Greenhouse frame.

# Instruction for assembling the 3x4m Greenhouse.



www.weisa.lv

Install the Roof skates fastening them with Self-tapping screws:

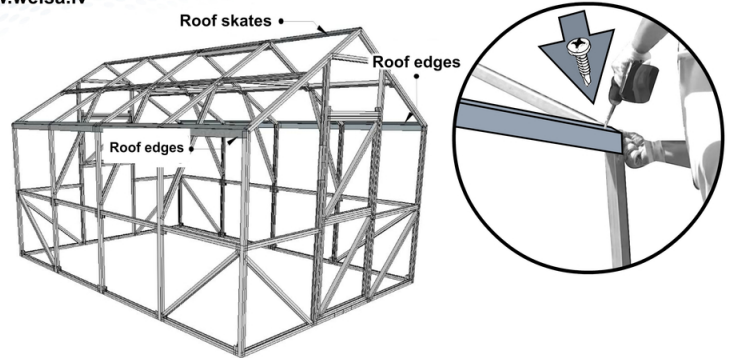

**13**

Assemble **Door and Window** panels:

Fasten the panel with frame screws (5.5x19) according to the diagram.

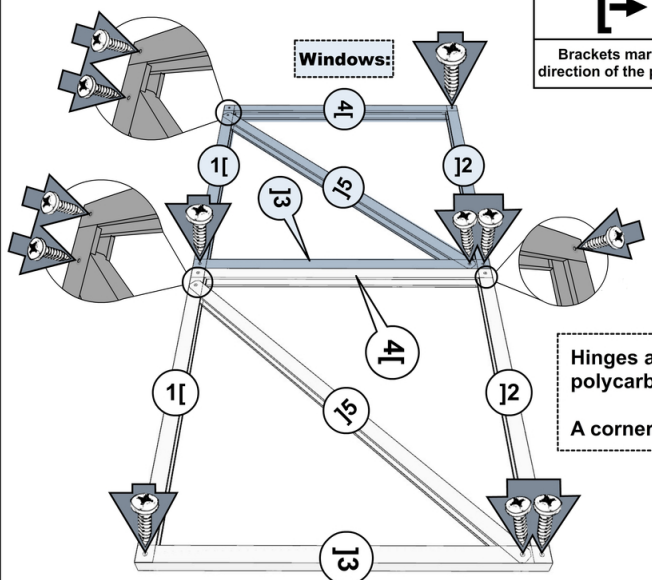

Brackets mark the direction of the profiles.

Hinges are installed on top of the polycarbonate covering.  
A corner is used to block the door.

Carefully flip the panel and fasten the other side of the panel with screws according to the diagram.

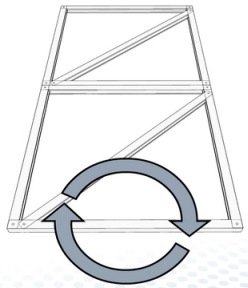

**14**



www.weisa.lv

**Polycarbonate Layout:**

Polycarbonate is installed with the advertisement sticker facing outside.

15

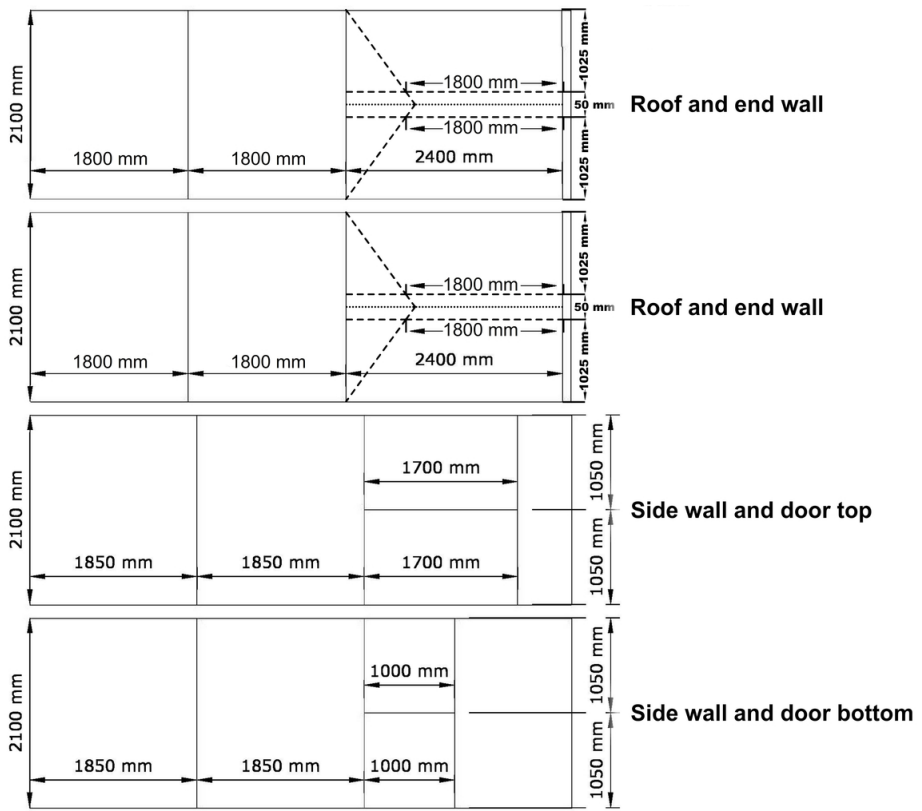

3x4 meters, 4 sheets

- Installation of polycarbonate on the walls and roof is provided with an overlap.
- For convenience, it is recommended to use a board during installation.



www.weisa.lv

Install the upper roof skates and roof edges on top of the polycarbonate coating using self-tapping screws:

16

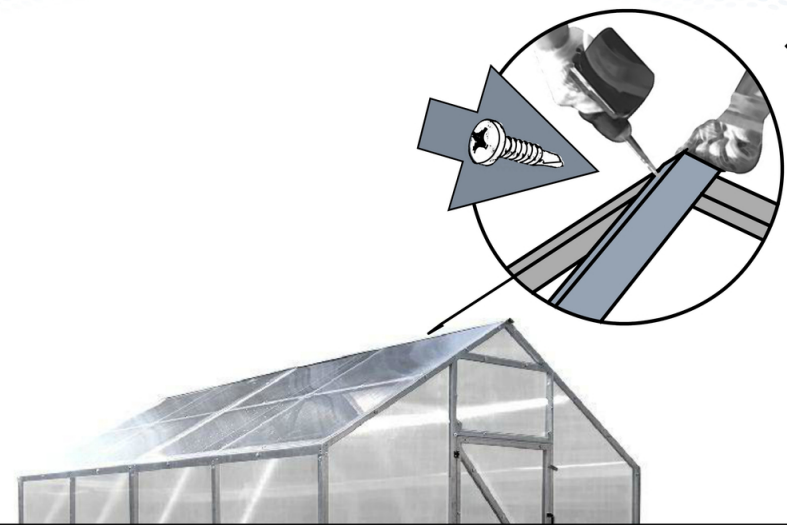



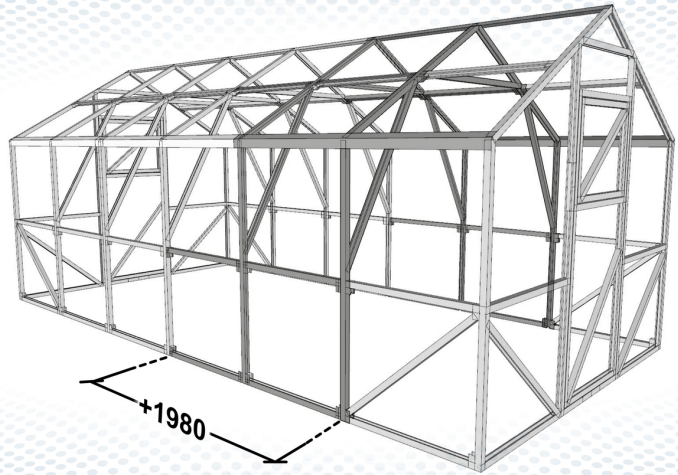

Instruction for assembling the Greenhouse 3x4m extension (1.98m).

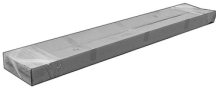
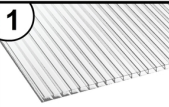
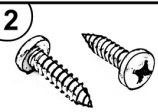
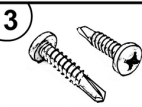
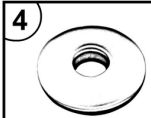

www.weisa.lv

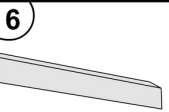
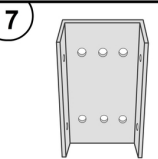
**Equipment**

|   |   |   |   |
|---|---|---|---|
|                | <b>Connection Element set</b><br>1 box.   |               | <b>Set of Frame profiles</b><br>1 boxes.  |
| <b>1</b><br>  | <b>2</b><br> | <b>3</b><br> | <b>4</b><br> |
| Polycarbonate<br>(thickness 4 mm,<br>1 sheet is 2,1x6m),<br>1 sheet +2meters.                   | Frame screws<br>(DIN7981-5.5x19) 190 pcs.   | For mounting<br>hinges and Roof skates.<br>Self-tapping screws<br>(DIN7504N-4.8x19) 18 pcs.     | Washers for polycarbonate<br>(DIN9021 M8) 60 pcs.   |
| <b>5</b><br> | <b>6</b><br>  |   | <b>7</b><br> |
| Screws for polycarbonate<br>(DIN7981-4.8x19) 60 pcs.  | Roof skates/edges<br>4 pcs.   |   | <b>Connection Elements</b><br>24 pcs.   |
|              |   |   |   |

**Main View:**

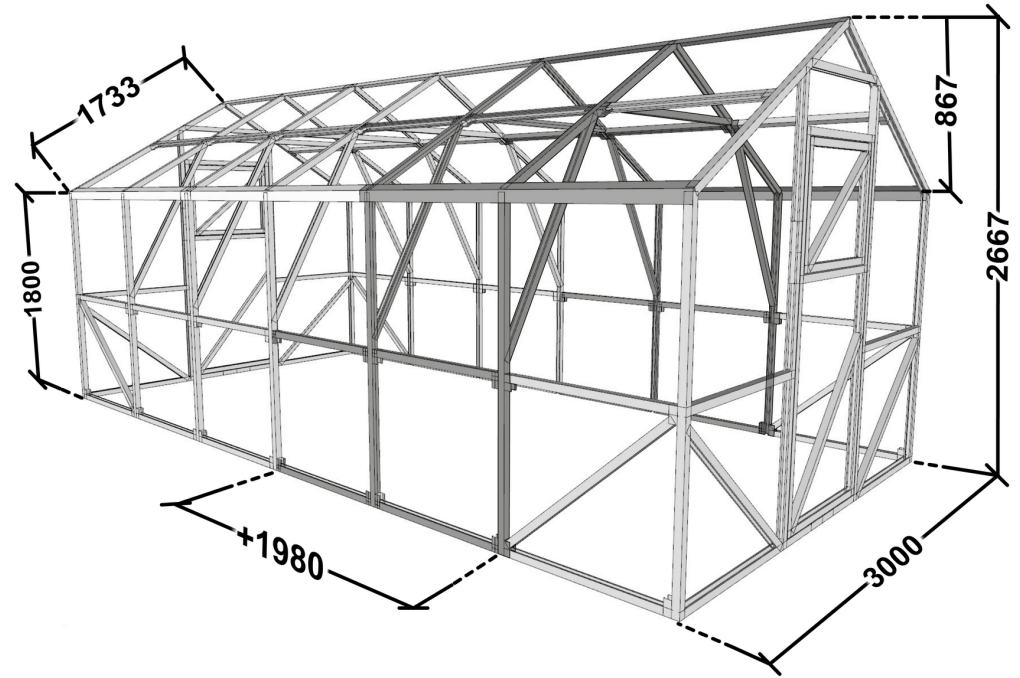



**Front View:**

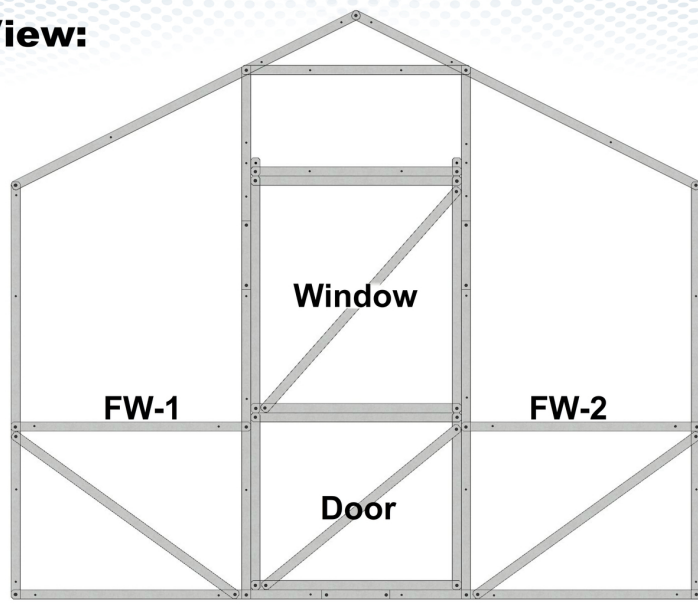

**Side View:**

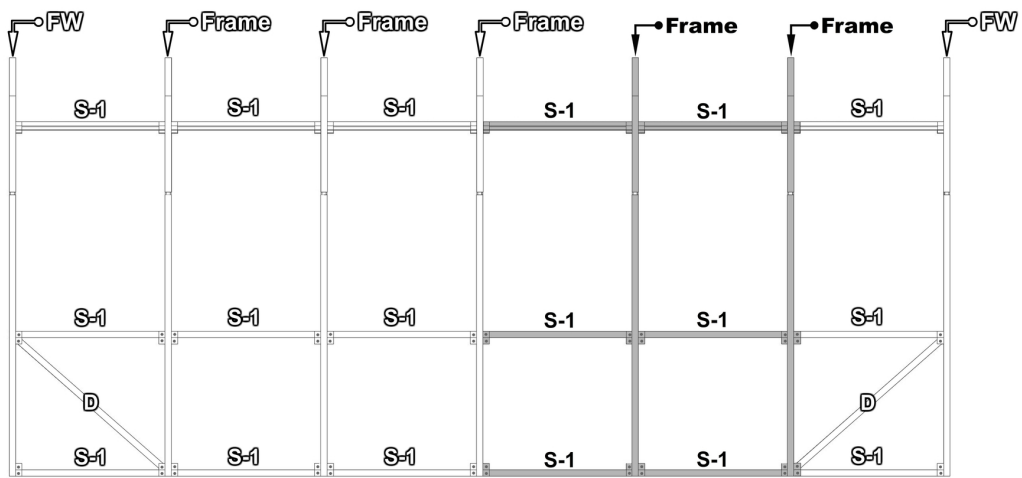

**Top View:**

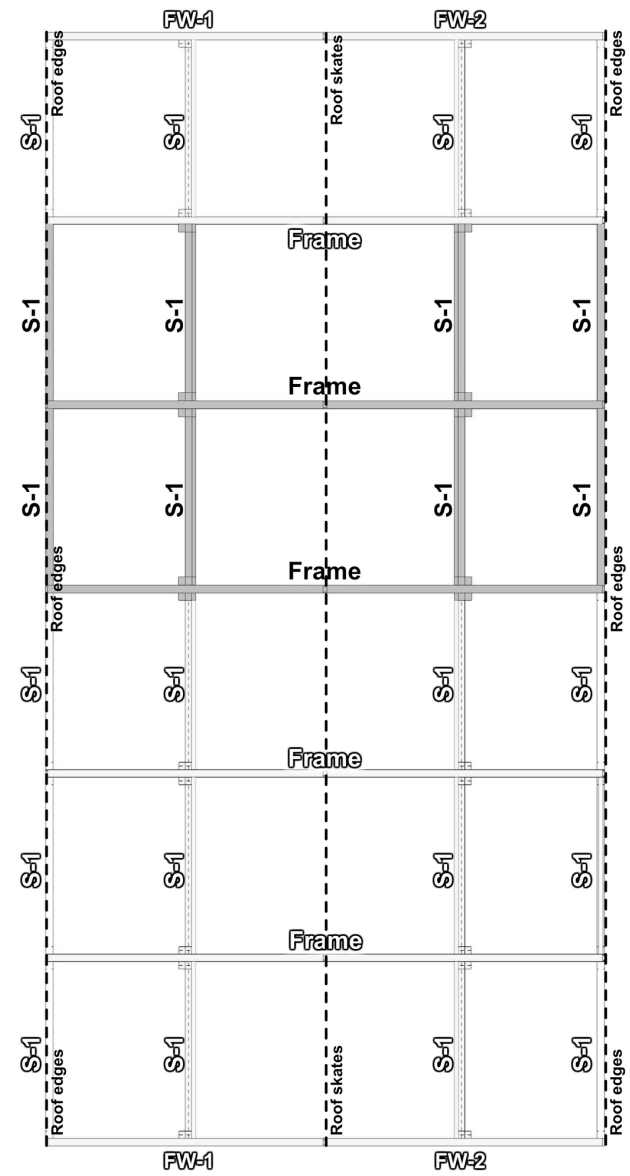





**1**  Unpack **One** box of **Connection Elements** and unpack **One** box of **"Frame"** profile.

**2** Assemble the **"Frame"** panel and fasten it with screws:

Fasten the panel with frame screws (5.5x19) according to the diagram.

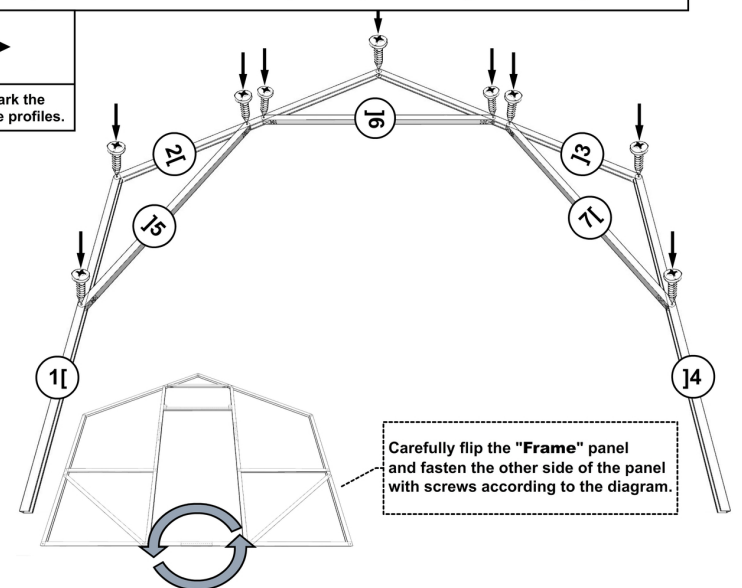

Brackets mark the direction of the profiles.

Carefully flip the **"Frame"** panel and fasten the other side of the panel with screws according to the diagram.

Fasten the **Connection Elements** with panels **"Frame"**:

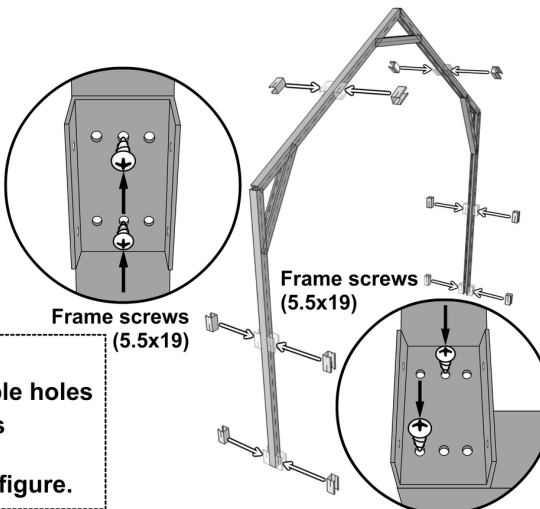

Frame screws (5.5x19)

**Connection Elements** are fastened on both sides through triple holes in **Frame** end wall panel beams with frame screws. Connection points are marked in the figure.

**3** Repeat step **1** and **2** to assemble **1** additional **"Frame"** panel ( 2 pcs in total ).

Page. **05**



**4** Assemble the frame by fastening together the panels and **Connection Elements**:

1) Connect the **"S-1"** and **"D"** connection elements to the end wall **"FW"**.  
 2) Connect the **"FRAME"** panel.  
 Fasten the panels with frame screws (5.5x19) according to the diagram:

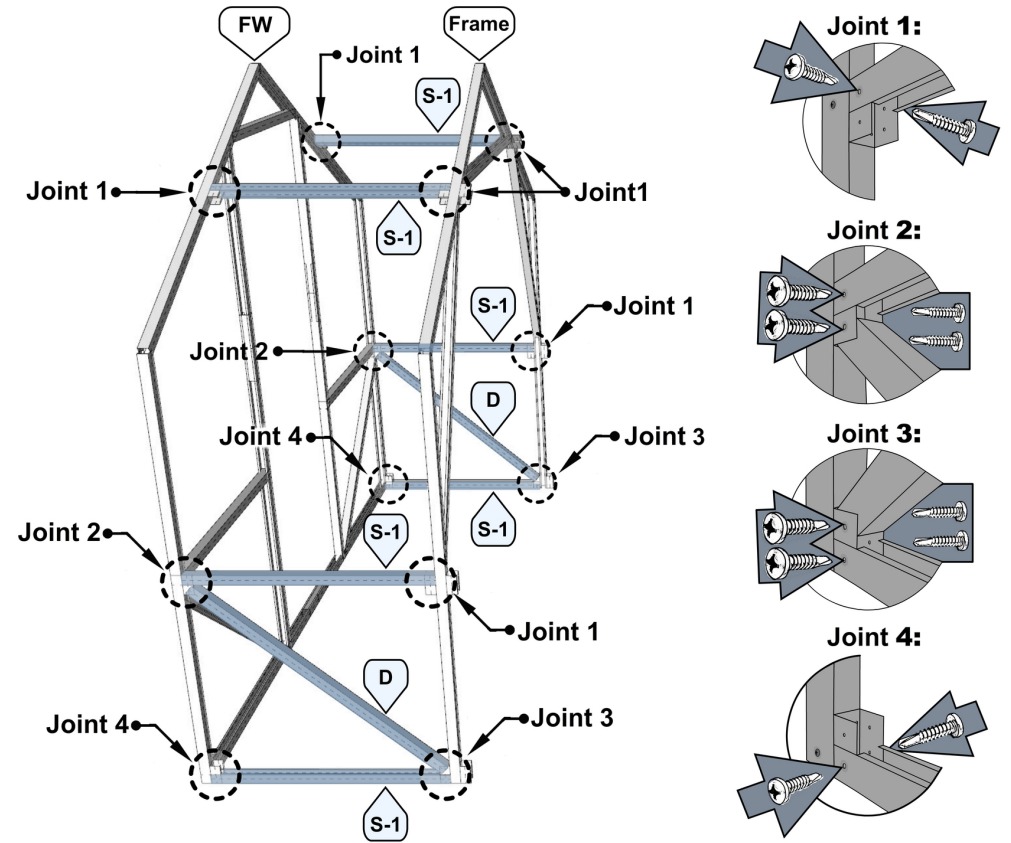

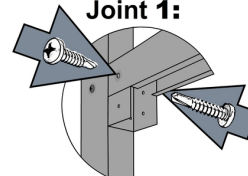
Joint 1: 

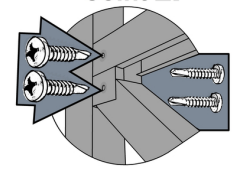
Joint 2: 

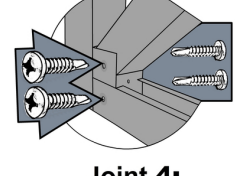
Joint 3: 

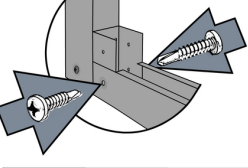
Joint 4: 

Similarly assemble the rest of the Greenhouse frame.

During montage assistance of a 2nd person is recommended.

Page. **06**



www.weisa.lv

5

Install the Roof skates fastening them with Self-tapping screws:

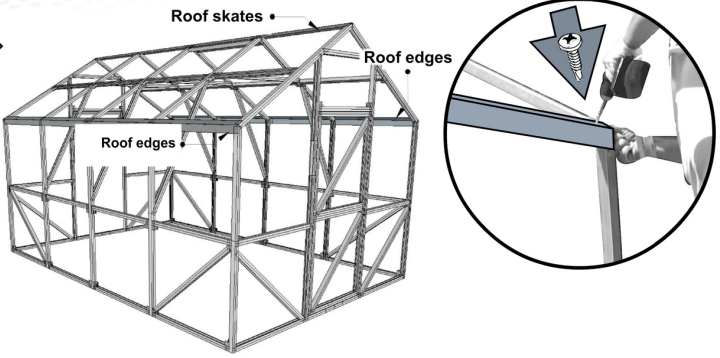

www.weisa.lv

7

Install the upper roof skates and roof edges on top of the polycarbonate coating using self-tapping screws:

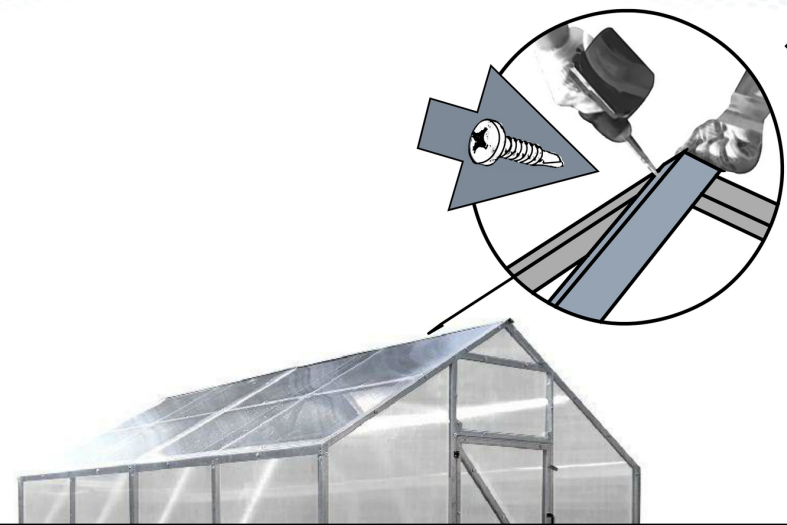

**Polycarbonate Layout:**

Polycarbonate is installed with the advertisement sticker facing outside.

6

